

KNCTEK GPS/GLONASS Mouse
SGM-2528GL Specification

Version 1.1
2016/01/15

This document contains information highly confidential to KNCTEK Company LTD (KNCTEK). It is provided for the sole purpose of the business discussions between supplier and KNCTEK and is covered under the terms of the applicable Non-Disclosure Agreements. Disclosure of this information to other parties is prohibited without the written consent of KNCTEK.

KNCTEK Company LTD.

14F-14, Byucksan Digital Valley 5th, 60-73,

Gasam-dong, Geumcheon-gu

SEOUL, KOREA

TEL: 82-2-839-5701

FAX: 82-2-830-5703

E-Mail: knc3@knctek.co.kr

<http://www.knctek.co.kr>

SGM-2528GL Specification

REVISION HISTORY	3
INTRODUCTION	4
PRODUCT FEATURES	4
PRODUCT APPLICATIONS	4
PRODUCT PICTURE & DIMENSION	5
SGM-2528GL SYSTEM BLOCK DIAGRAM	5
TECHNICAL SPECIFICATION	6
ORDERING INFORMATION.....	8
HARDWARE INTERFACE	9
I/O INTERFACE.....	10
PACKING INFORAMTION.....	11
GPS/GLONASS RECEIVER USER'S TIP	12
NMEA PROTOCOL	13
CONTACT INFORMATION SECTION	21

Revision History

1. 2014-06-02 : Initiated Version 1.0
2. 2016-01-15 : Updated Version 1.1 for Specification renewal.

SGM-2528GL Operational Manual

INTRODUCTION

The **SGM-2528GL** is the newest generation of KNCTEK GPS/GLONASS. The GPS/GLONASS Mouse is powered by SkyTraq technology and KNCTEK proprietary navigation algorithm that providing you more stable navigation data. The miniature design is the best choice to be embedded in a portable device various Trackers, various Vehicle & personal Locaters & Trackers and etc. The excellent sensitivity of **SGM-2528GL** gets the great performance when going though the urban canyon and foliage environmental condition.

PRODUCT FEATURES

- ✧ GPS, GLONASS, QZSS, SBAS(WAAS, MSAS, EGNOS, GAGAN) supported
- ✧ Total 167 channels: 139 Channels for Acquisition, 28 Channels for Tracking
- ✧ Operable from 3.3V/ Typ 64mA for Acquisition and 54mA for Tracking Mode
- ✧ Signal Detection better than -165dBm in Ultra High Tracking Sensitivity
- ✧ Enhanced Cold Acquisition Sensitivity at -148dBm and Reacquisition at -160dBm
- ✧ Fast TTFF <28 seconds in Warm start and 29 seconds for Cold start
- ✧ 4 second TTFF with AGPS
- ✧ Multipath detection and suppression
- ✧ Jamming detection and mitigation
- ✧ AGPS and SAEE(Self-aided ephemeris estimation) Supported
- ✧ Excellent Sensitive for Urban Canyon and Foliage Environmental condition
- ✧ NMEA-0183 compliant protocol
- ✧ Automotive-grade Quality GPS/GLONASS solution
- ✧ Small form factor(30 x 42.5 x 13.2mm)
- ✧ ODM/OEM development is fully supported Application Engineering
- ✧ GPS/GLONASS Fixed Status Display LED Indicator
- ✧ RoHS compliant

PRODUCT APPLICATION

- ✧ Automotive applications
- ✧ Speed camera detector
- ✧ Personal and Car navigation
- ✧ Marine navigation

✧ Timing application and the others

PRODUCT PICTURE



SGM-2528GL SYSTEM BLOCK DIAGRAM

The SGM-2528GL consists of SkyTraq chipsets Technology, KNCTEK LNA and proprietary software. The system is described as follows.

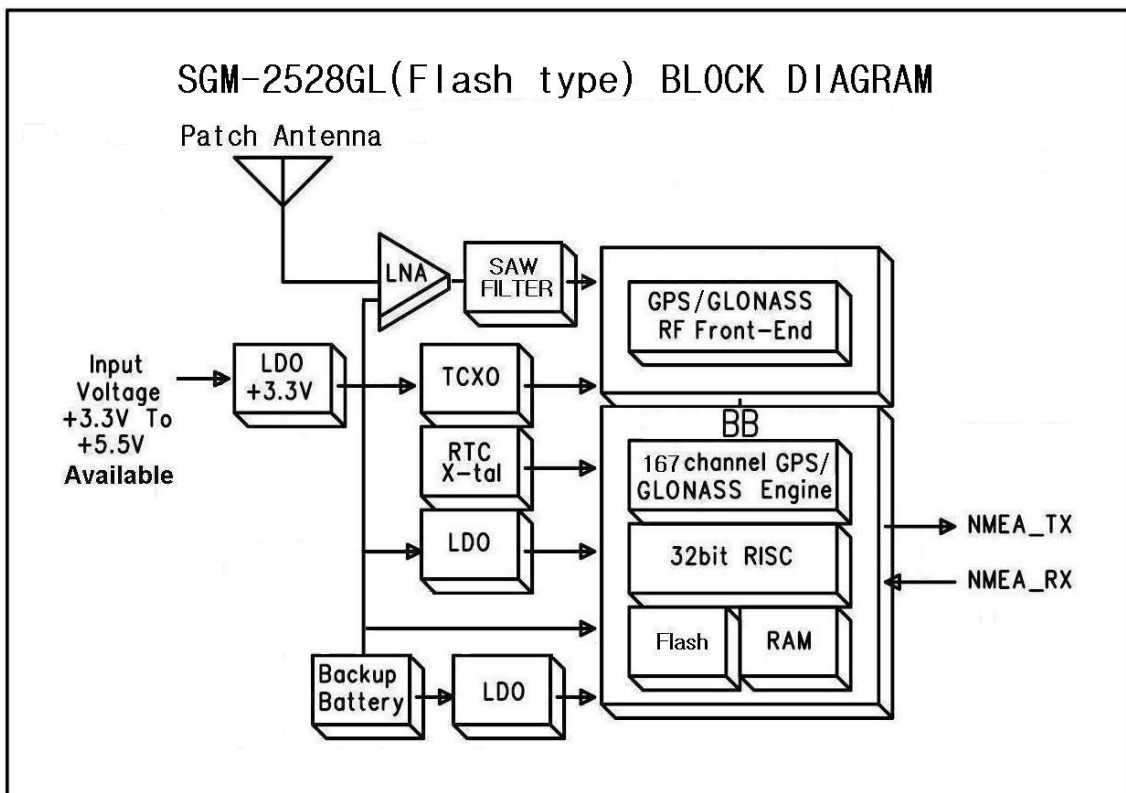

TECHNICAL SPECIFICATION
1. Electrical Characteristics
1.1 Absolute Maximum Rating

Parameter	Symbol	Min	Max	Units
Power Supply				
Power Supply Volt.	VCC	-0.3	6	V
Input Pins				
Input Pin Voltage I/O	RX	-0.3	3.6	V
Backup Battery	Vbat	1.8	3.6	V
Environment				
Operating Temperature	Topr	-30	85	°C
Storage Temperature	Tstg	-40	85	°C
Backup Battery operating temperature ¹	Tbat	-20	65	°C
Humidity			95	%

** ¹ Backup Battery operating temperature depends on Battery characteristics

Note : Absolute maximum ratings are stress ratings only, and functional operation at the maximums is not guaranteed. Stress beyond the limits specified in this table may affect device reliability or cause permanent damage to the device.

For functional operating conditions, please refer to the operating conditions tables as follow.

1.2 Operating Condition

Parameter	Symbol	Condition	Min	Typ	Max	Units
Power supply voltage	V _{CC}		3.3	5.0	5.5	V
Power Supply voltage ripple	V _{CC_PP}	V _{CC} = 5.0V			50	mV
Acquisition current	I _{CCA}	V _{CC} = 3.3V		64		mA
Tracking current	I _{CCT}	V _{CC} = 3.3V		54		mA
Input high voltage	V _{IH}		2.0			V
Input low voltage	V _{IL}				0.8	V
Output high voltage	V _{OH}		2.4			V
Output low voltage	V _{OL}				0.4	V

2. General & Performance Specification

Parameter	Specification
Receiver Type	GPS/GLONASS, 139 Channel Acquisition, 28 Channel Tracking
Sensitivity	Tracking -165dBm Re-acquisition -160dBm Cold Start -148dBm
Accuracy	Position 2.5m CEP Velocity 0.1m/s Timing(PPS) 10ns RMS
Acquisition Time	Cold Start 29 sec. typical (Open sky ¹) Warm Start 28 sec. typical (Open sky) Hot Start 1 sec. typical (Open sky) Reacquisition Time 1 sec(Open sky, re-appear after some seconds) AGPS Support 4 sec. avg SA-GPS Support Self-aided ephemeris estimation : 15 sec. avg
Power Consumption	Tracking 54mA @ 3.3V Acquisition 64mA Back-up 9uA @ 3V
Navigation Data Update Rate	1Hz_Default In case of using Binary input : Max 20Hz ** Please refer to the Binary Input Message
Operational Limits	Velocity Max 515 m/s Altitude Max 18,000m Acceleration Less than 4g(39.2m/sec ²)
Mechanical data	Dimension 30X42.5X13.2mm Weight(with case and cable) 55grams ±5%(3M Cable)
Protocol	NMEA-0183 V3.01 GNGGA 1Hz GNLL 1Hz GNGSA 1Hz GPGSV 1/3Hz(one time per 3sec) GLGSV 1/3Hz GNRMC 1Hz GNVTG 1Hz GNZDA 1Hz

** ¹Open Sky means no obstructions in the sky

ORDERING INFORMATION

Cable for customer request : Refer to page 10 for connector type
(Default: TTL output/9,600baud)

HARDWARE INTERFACE
Pin Description

PIN	SIGNAL NAME	I/O	DESCRIPTION	CHARACTER
1	VCC	P	DC Power Supply Voltage input	DC 3.3V to 5V \pm 10%
2	TXD	O	NMEA_TX : UART Output	3.3V LVTTTL
3	RXD	I	NMEA_RX : UART Input	3.3V LVTTTL
4	GND	P	Digital Reference Ground	Digital Reference Ground

VCC DC Power Input

This is the main power supply for the Engine board. The power range is **DC +5V \pm 10%** (3.3V to 5.5V Acceptable). Suitable decoupling must be provided by external decoupling circuitry.

GND

GND provides the ground for the Engine board. Connect all grounds.

TXD







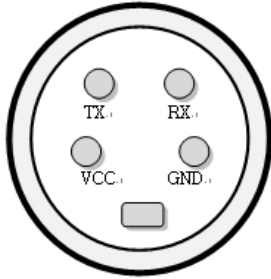

NMEA_TX, UART output, 3.3V LVTTTL logic level. This is the main transmit channel and is used to output navigation and measurement data to user written software. The default setup is NMEA Output, 9600bps, 8 data bits, no parity, 1 stop bit. The default sentences are GNGGA, GNLL, GNGSA, GPGSV, GLGSV, GNRMC, GNVTG, GNZDA.

GNGGA, GNLL, GNGSA, GNRMC, GNVTG, GNZDA are once per second and GPGSV, GLGSV is once per 3 second.

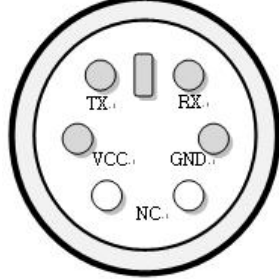
RXD

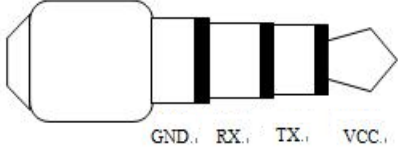
NMEA_RX, UART input, 3.3V LVTTTL logic level. This is the main receiving channel and is used to receive software commands to the Engine board from user written software.

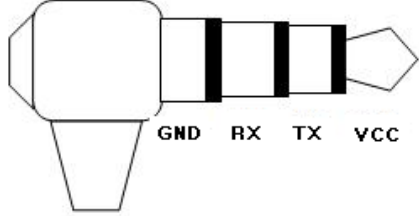
I/O INTERFACE

<p>Mini Din Jack 4pin Φ9.0</p>		
<p>Mini Din Jack 6pin Φ9.0</p>		
<p>Stereo Jack (Straight) Φ2.5 Φ3.5</p>		
<p>Stereo Jack (Angle) Φ2.5 Φ3.5</p>		

Packing Information

TBD : To be determined

GPS/GLONASS Receiver User's Tip

1. GPS/GLONASS signal will be affected by weather and environment conditions, thus suggest to use the GPS/GLONASS receiver under less shielding environments to ensure GPS/GLONASS receiver has better receiving performance.
2. When GPS/GLONASS receiver is moving, it will prolong the time to fix the position, so suggest to wait for the satellite signals to be locked at a fixed point when first power-on the GPS/GLONASS receiver to ensure to lock the GPS/GLONASS signal at the shortest time.
3. The following situation will affect the GPS/GLONASS receiving performance:
 - a. Solar control filmed windows.
 - b. Metal shielded, such as umbrella, or in vehicle.
 - c. Among high buildings.
 - d. Under bridges or tunnels.
 - e. Under high voltage cables or near by radio wave sources, such as mobile phone base stations.
 - f. Bad or heavy cloudy weather.
4. If the satellite signals can not be locked or encounter receiving problem (while in the urban area), the following steps are suggested:
 - a. Move to another open space or reposition GPS/GLONASS receiver toward the direction with fewer blockages.
 - b. Move the GPS/GLONASS receiver away from the interference resources.
 - c. Wait until the weather condition is improved.

While a GPS/GLONASS with a backup battery, the GPS/GLONASS receiver can fix a position immediately at next power-on if the build-in backup battery is full-recharged.

NMEA Protocol Overview

The output protocol supports NMEA-0183 standard. The implemented message include GGA, GLL, GSA, GSV, VTG, RMC, ZDA and GNS messages. The NMEA message output has the following sentence structure:

\$aacc,c-c*hh<CR><LF>

The detail of the sentence structure is explained in Table 1.

Table 1 : The NMEA sentence structure

character	HEX	Description
"\$"	24	Start of sentence
Aaacc		Address field. "aa" is the talked identifier. "ccc" identifies the sentence type
","	2C	Field delimiter
C-c		Data sentence block
"*"	2A	Checksum delimiter
Hh		Checksum field.
<CR><LF>	0D0A	Ending of sentence. (carriage return, line feed)

Table 2 : Overview of NMEA messages

\$GNGGA	Time, position, and fix related data of the receiver.
\$GNLL	Position, time and fix statue.
\$GNGSA \$GPGSA \$GLGSA	Used to represent the ID's of satellites which are used for position fix. When both and GPS and GLONASS satellites are used in position solution, a \$GNGSA sentence is used for GPS satellites and another \$GNGSA sentence is used for GLONASS satellites. When only GPS satellites are used for position fix, a single \$GPGSA sentence is output. When only GLONASS satellites are used for position fix, a single \$GLGSA sentence is output.
\$GPGSV \$GLGSV	Satellite information about elevation, azimuth and CNR, \$GPGSV is used for GPS satellites, while \$GLGSV is used of GLONASS satellites
\$GNRMC	Time, date, position, course and speed data.
\$GNVTG	Course and speed relative to the ground
\$GNZDA	UTC, day, month and year and time zone.

GGA - Global Positioning System Fix Data

Time, position and fix related data for a GPS receiver.

Structure:

```
$--GGA,hhmmss.sss,ddmm.mmmm,a,dddmm.mmmm,a,x,xx,x.x,x.x,M,,,,,xxxx*hh<CR><LF>
```

1 2 3 4 5 6 7 8 9 10 11

Example:

```
$GNGGA,111636.932,2447.0949,N,12100.5223,E,1,11,0.8,118.2,M,,,,,0000*02<CR><LF>
```

Field	Name	Example	Description
1	UTC Time	111636.932	UTC of position in hhmmss.sss format, (000000.000 ~ 235959.999)
2	Latitude	2447.0949	Latitude in ddmm.mmmm format Leading zeros transmitted
3	N/S Indicator	N	Latitude hemisphere indicator, 'N' = North, 'S' = South
4	Longitude	12100.5223	Longitude in dddmm.mmmm format Leading zeros transmitted
5	E/W Indicator	E	Longitude hemisphere indicator, 'E' = East, 'W' = West
6	GPS quality indicator	1	GPS quality indicator 0: position fix unavailable 1: valid position fix, SPS mode 2: valid position fix, differential GPS mode 3: GPS PPS Mode, fix valid 4: Real Time Kinematic. System used in RTK mode with fixed integers 5: Float RTK. Satellite system used in RTK mode. Floating integers 6: Estimated (dead reckoning) Mode
7	Satellites Used	11	Number of satellites in use, (00 ~ 24)
8	HDOP	0.8	Horizontal dilution of precision, (00.0 ~ 99.9)
9	Altitude	108.2	mean sea level (geoid), (-9999.9 ~ 17999.9)
10	DGPS Station ID	0000	Differential reference station ID, 0000 ~ 1023 NULL when DGPS not used
11	Checksum	02	

GLL – Latitude/Longitude

Latitude and longitude of vessel position, time of position fix and status.

Structure:

\$--GLL,ddmm.mmmm,a,dddmm.mmmm,a,hhmmss.sss,A,a*hh<CR><LF>

1 2 3 4 5 6 7 8

Example:

\$GNGLL,2447.0944,N,12100.5213,E,112609.932,A,A*57<CR><LF>

Field	Name	Example	Description
1	Latitude	2447.0944	Latitude in ddmm.mmmm format Leading zeros transmitted
2	N/S Indicator	N	Latitude hemisphere indicator 'N' = North 'S' = South
3	Longitude	12100.5213	Longitude in dddmm.mmmm format Leading zeros transmitted
4	E/W Indicator	E	Longitude hemisphere indicator 'E' = East 'W' = West
5	UTC Time	112609.932	UTC time in hhmmss.sss format (000000.000 ~ 235959.999)
6	Status	A	Status, 'A' = Data valid, 'V' = Data not valid
7	Mode Indicator	A	Mode indicator 'N' = Data not valid 'A' = Autonomous mode 'D' = Differential mode 'E' = Estimated (dead reckoning) mode
8	Checksum	57	

GSA – GNSS DOP and Active Satellites

GPS receiver operating mode, satellites used in the navigation solution reported by the GGA or GNS sentence and DOP values.

Structure:

```
$--GSA,A,x,xx,xx,xx,xx,xx,xx,xx,xx,xx,xx,xx,xx,x.x,x.x,x.x*hh<CR><LF>
  1 2 3 3 3 3 3 3 3 3 3 3 3 3 4 5 6 7
```

Example:

```
$GPGSA,A,3,05,12,21,22,30,09,18,06,14,01,31,,1.2,0.8,0.9*36<CR><LF>
```

Field	Name	Example	Description
1	Mode	A	Mode 'M' = Manual, forced to operate in 2D or 3D mode 'A' = Automatic, allowed to automatically switch 2D/3D
2	Mode	3	Fix type 1 = Fix not available 2 = 2D 3 = 3D
3	Satellite used 1~16	05,12,21,22,30 ,09,18,06,14,0 1,31,,	Satellite ID number, 01 ~ 32 are for GPS; 33 ~ 64 are for WASS(PRN minus 87); 65 ~ 96 are for GLONASS(64 plus slot numbers); 193 ~ 197 are for QZSS. Maximally 12 satellites are included in each GSA sentence.
4	PDOP	1.2	Position dilution of precision (00.0 to 99.9)
5	HDOP	0.8	Horizontal dilution of precision (00.0 to 99.9)
6	VDOP	0.9	Vertical dilution of precision (00.0 to 99.9)
7	Checksum	36	

GSV – GNSS Satellites in View

Number of satellites (SV) in view, satellite ID numbers, elevation, azimuth, and SNR value. Four satellites maximum per transmission.

Structure:

```
$--GSV,x,x,xx,xx,xx,xxx,xx,...,xx,xx,xxx,xx *hh<CR><LF>
    1 2 3 4 5 6 7 4 5 6 7 8
```

Example:

```
$GPGSV,4,1,16,05,54,069,45,12,44,061,44,21,07,184,46,22,78,289,47*72<CR><LF>
$GPGSV,4,2,16,30,65,118,45,09,12,047,37,18,62,157,47,06,08,144,45*7C<CR><LF>
$GPGSV,4,3,16,14,39,330,42,01,06,299,38,31,30,256,44,32,36,320,47*7B<CR><LF>
$GPGSV,4,4,16,42,64,169,45,50,74,261,44,21,07,184,46,193,68,189,47*72<CR><LF>
```

Field	Name	Example	Description
1	Number of message	4	Total number of GSV messages to be transmitted (1-4)
2	Sequence number	1	Sequence number of current GSV message
3	Satellites in view	16	Total number of satellites in view (00 ~ 16)
4	Satellite ID	05	Satellite ID number, 01 ~ 32 are for GPS; 33 ~ 64 are for WASS(PRN minus 87); 65 ~ 96 are for GLONASS(64 plus slot numbers); 193 ~ 197 are for QZSS. Maximally 4 satellites are included in each GSV sentence.
5	Elevation	54	Satellite elevation in degrees, (00 ~ 90)
6	Azimuth	069	Satellite azimuth angle in degrees, (000 ~ 359)
7	SNR	45	C/No in dB (00 ~ 99) Null when not tracking
8	Checksum	72	

RMC – Recommended Minimum Specific GNSS Data

Time, date, position, course and speed data provided by a GNSS navigation receiver.

Structure:

```
$--RMC,hhmmss.sss,A,dddmm.mmmm,a,dddmm.mmmm,a,x.x,x.x,ddmmy,,a*hh<CR><LF>
```

1 2 3 4 5 6 7 8 9 10 11

Example:

```
$GNRMC,111636.932,A,2447.0949,N,12100.5223,E,000.0,000.0,030407,,A*61<CR><LF>
```

Field	Name	Example	Description
1	UTC time	0111636.932	UTC time in hhmmss.sss format (000000.000 ~ 235959.999)
2	Status	A	Status 'V' = Navigation receiver warning 'A' = Data Valid
3	Latitude	2447.0949	Latitude in dddmm.mmmm format Leading zeros transmitted
4	N/S indicator	N	Latitude hemisphere indicator 'N' = North 'S' = South
5	Longitude	12100.5223	Longitude in dddmm.mmmm format Leading zeros transmitted
6	E/W Indicator	E	Longitude hemisphere indicator 'E' = East 'W' = West
7	Speed over ground	000.0	Speed over ground in knots (000.0 ~ 999.9)
8	Course over ground	000.0	Course over ground in degrees (000.0 ~ 359.9)
9	UTC Date	030407	UTC date of position fix, ddmmyy format
10	Mode indicator	A	Mode indicator 'N' = Data not valid 'A' = Autonomous mode 'D' = Differential mode 'E' = Estimated (dead reckoning) mode
11	checksum	61	

VTG – Course Over Ground and Ground Speed

The Actual course and speed relative to the ground.

Structure:

\$--VTG,x.x,T,,M,x.x,N,x.x,K,a*hh<CR><LF>
 1 2 3 4 5

Example:

\$GNVTG, 000.0,T,,M,000.0,N,0000.0,K,A*3D<CR><LF>

Field	Name	Example	Description
1	Course	000.0	True course over ground in degrees (000.0 ~ 359.9)
2	Speed	000.0	Speed over ground in knots (000.0 ~ 999.9)
3	Speed	0000.0	Speed over ground in kilometers per hour (0000.0 ~ 1800.0)
4	Mode	A	Mode indicator 'N' = not valid 'A' = Autonomous mode 'D' = Differential mode 'E' = Estimated (dead reckoning) mode
5	Checksum	3D	

ZDA – Time & Date

UTC, day, month, year and local time zone.

Structure:

\$--ZDA,hhmmss.sss,xx,xx,xxxx,xx,xx*hh<CR><LF>

1 2 3 4 5 6 7

Example:

\$GPZDA,052633.376,13,07,2012,00,00*51<CR><LF>

Field	Name	Example	Description
1	UTC time	0111636.932	UTC time in hhmmss.sss format (000000.000 ~ 235959.999)
2	Day	13	Day, 01 to 31
3	Month	07	Month, 01 to 12
4	Year	2012	Year in yyyy format
5	Local zone hours	00	Local zone hours, 00 to +/- 13 hrs
6	Local zone minutes	00	Local zone minutes, 00 to +59
7	checksum	51	

Contact Information Section

Contact : knc3@knctek.co.kr

Web Site: www.knctek.co.kr

Headquarter :

**14F-14, 60-73 Byucksan Digital Valley 5th,
Gasan-dong, Geumcheon-gu
SEOUL, KOREA
TEL: 82-2-839-5701
FAX: 82-2-830-5703**